

SELLEYS®

IF IT'S SELLEYS IT WORKS™



SELLEYS ELECTRIC SPRAYER S100
SELLEYS ELECTRIC SPRAYER S100B

OPERATING MANUAL

CONTENTS

1. SAFETY INFORMATION

- 1.1 General Safety Precautions
- 1.2 Specific Safety Hazards and Precautions
- 1.3 Earthing Instructions

2. COATINGS

- 2.1 Suitable Coatings
- 2.2 Preparation of Coating Materials
- 2.3 Viscosity
- 2.4 Coatings Containing Abrasive Materials

3. EQUIPMENT

4. OPERATING INSTRUCTIONS

- 4.1 Preparing the Material
- 4.2 Preparing and Filling the Sprayer
- 4.3 Adjusting the Spray Length
- 4.4 Adjusting the Paint Volume
- 4.5 Adjusting the Spray Pattern
- 4.6 Correct Method of Spraying
- 4.7 Replacing the Nozzle and Needle

5. MALFUNCTIONS

1. SAFETY INFORMATION

Please read the following important information carefully.

The following symbols indicate specific types of safety hazards.



Indicates a potential hazard that may cause **serious injury to the operator or loss of life.**



Indicates a potential hazard that may cause **minor injury to the operator or to the equipment.**



Indicates **important information.**



WARNING

This unit is capable of extremely high spraying pressures that can cause serious and/or minor injury by injection and extensive damage to property.



IMPORTANT

All replacement parts and accessories should **ONLY** be purchased from SELLEYS or an authorised distributor of SELLEYS equipment. Servicing should **ONLY** be carried out by SELLEYS or an authorised distributor of SELLEYS equipment. If these conditions are not met, the operator assumes all liability for injury and property damage arising from the use of this unit.

1.1 GENERAL SAFETY PRECAUTIONS

✘ NEVER

- use the spray gun without the safety guard in place
- operate faulty units or use faulty accessories
- attempt to repair a damaged hose
- leave this equipment unattended
- move the unit when it is running
- spray outside on windy days

✔ ALWAYS

- ensure that this unit is properly earthed
- ensure that the power cord, air hose and spray hoses are optimally routed to minimise slip, trip and fall hazards
- immediately and thoroughly clean up all material and solvent spills to prevent slip hazards
- follow the material manufacturer's instructions for safe handling of coating materials
- unplug the cord from the outlet before cleaning, maintaining or repairing this unit
- keep the power cord plug in sight during use to prevent accidental shutdowns and startups
- wear ear protection to protect against possible hearing loss from the noise produced by this unit, which can exceed 85 dB(A)
- keep this unit out of reach of children, unqualified adults and animals
- comply with local codes regarding ventilation, fire prevention, and operation

1.2 SPECIFIC SAFETY HAZARDS AND PRECAUTIONS

SAFETY PRECAUTIONS TO PREVENT INJECTION INJURY



WARNING

Serious risk of injection injury. This equipment produces a high-pressure stream that can pierce the skin and subcutaneous tissues, resulting in severe injury and even possible amputation.

✘ NEVER

- put your fingers, hands or any other parts of your body into the spray jet
- point the spray gun at yourself or anyone else (including animals)
- allow the fluid stream to come into contact with any part of your body
- allow any leak in the fluid hose to come into contact with any part of your body
- put your hand in front of the gun

NOTE: Gloves do not provide full protection against injection injury.

✔ ALWAYS

- ensure that the gun trigger is locked, the fluid pump is shut off, and all pressure is released before servicing, cleaning the nozzle holder, changing spray tip, or leaving the unit unattended

NOTE: Turning off the engine will not release the pressure. The PRIME/SPRAY valve or pressure bleed valve must be turned to their appropriate positions to relieve system pressure.

- ensure that the nozzle holder remains in place during spraying
- remove the spray tip before flushing or cleaning the system
- carefully check the paint hose for leaks before each use, as even small leaks can cause injection injury
- ensure that all accessories, including but not limited to spray tips, guns, extensions and hose, are rated at or above the maximum operating pressure range of the sprayer



IMPORTANT MEDICAL INFORMATION

Injection injury is a traumatic injury that requires immediate medical attention. Any laceration of the skin, no matter how minor it seems, should not be treated as a simple cut. Fully inform the medical team about the coatings or solvents involved, as some coatings are toxic when injected directly into the bloodstream. For serious injuries, a plastic surgeon or reconstructive hand surgeon should be consulted.

SAFETY PRECAUTIONS TO PREVENT EXPLOSIONS AND FIRE



WARNING

This equipment produces a high-pressure stream that can pierce the skin and subcutaneous tissues, resulting in severe injury and even possible amputation.

✗ NEVER

- use plastic drop cloths or enclose the spray area with plastic sheets, as plastic can cause static sparks
- smoke in the spray area
- use any materials with a flashpoint lower than 21 °C (70 °F)

NOTE: Flashpoint is the temperature at which a fluid can produce sufficient vapours to ignite.

✓ ALWAYS

- ensure that the spray area is well-ventilated to prevent the build-up of flammable vapours
- avoid all ignition sources such as static electricity sparks, electrical appliances, flames, pilot lights, hot objects, and sparks from connecting and disconnecting power cords and/or working light switches
- flush the unit into a separate metal container, at the lowest possible pump pressure and with the spray tip removed
- hold the gun firmly against the side of the container to prevent static sparks
- have a fire extinguisher nearby
- place the sprayer at a minimum of 6.1 metres (20 feet) from the surface to be sprayed, extending the hose if necessary. Since flammable vapours are often heavier than air, the floor area must be well ventilated. The pump contains arcing parts that emit sparks, which can ignite vapours.
- ensure that the equipment and objects in and around the spray area are properly grounded to prevent static sparks
- ensure that you are using a conductive or earthed high pressure hose
- ensure that the gun is earthed through the hose connection
- ensure that the power cord is connected to a grounded circuit
- ensure that the unit is connected to an earthed object such as a water pipe, steel beam, or other electrically earthed surface, via the green earthing wire
- strictly follow the material and solvent manufacturer's warnings and instructions, and read the coating material's MSDS (Material Safety Data Sheet) and technical information before use

SAFETY PRECAUTIONS TO PREVENT EXPLOSIONS DUE TO INCOMPATIBLE MATERIALS



WARNING

Serious risk of explosions due to incompatible materials. Accidental explosions due to incompatible materials can cause serious injury and/or extensive damage to property.

✗ NEVER

- use materials that contain bleach or chlorine
- use halogenated hydrocarbon solvents such as methylene chloride and 1,1,1-trichloroethane

NOTE: These substances are not compatible with aluminium and may cause an explosion. If you are in any doubt over a material's compatibility with aluminium, check with your coating supplier.

SAFETY PRECAUTIONS TO PREVENT HARM FROM TOXIC VAPOURS



WARNING

Vapours from paints, solvents, insecticides, and other materials can be harmful in the event of inhalation or contact with any part of the body. Symptoms include severe nausea, fainting and poisoning.

✓ ALWAYS

- use a respirator or mask
- wear protective eyewear
- wear protective clothing

1.3 EARTHING INSTRUCTIONS

✗ NEVER

- operate this unit unless you are sure that it has been properly earthed
- modify the earthing plug

✓ ALWAYS

- ensure that the earthing plug is plugged into an outlet that has been properly installed and earthed in accordance with local codes
- seek the advice of a qualified electrician if you need a new outlet installed to fit the earthing plug, do not fully understand these earthing instructions, or are unsure as to whether this unit is properly earthed



WARNING

Incorrect installation of the earthing plug can result in electric shock. If you need to repair or replace the cord or plug, do not connect the green earthing wire to either blade terminal.



IMPORTANT

The wire with insulation, which has a green outer surface with or without yellow stripes, is the earthing wire. It must be connected to the earthing pin.

A list of the materials used in the construction of this unit is available upon request for the purpose of determining compatibility with coating materials.

2. COATINGS

Read the following important information carefully.

2.1 SUITABLE COATINGS

This unit is suitable for the application of:

- dilutable lacquers and paints
- coatings containing solvents
- 2-component coating materials
- dispersions
- latex paints

Do not spray coatings other than those listed above without the prior approval of SELLEYS or the authorised distributor of this unit.

2.2 PREPARATION OF COATING MATERIALS

Always filter and stir the coating material before application. To prevent downtime, make sure that no air bubbles are introduced, especially when stirring the coating material with motor-driven agitators.

2.3 VISCOSITY

This unit is able to process highly viscous coating materials of up to around 20,000 mPa-s.

Highly viscous coating materials can be diluted according to the manufacturer's instructions.

2.4 COATINGS CONTAINING ABRASIVE MATERIALS

Coatings that contain sharp-edged aggregates and additional materials cause intense wear and tear on this unit's parts, including its valves, high-pressure hose, spray gun and spray tip.

Use of abrasive coatings may shorten the working life of this unit.

3. EQUIPMENT

Please read the following important information carefully.

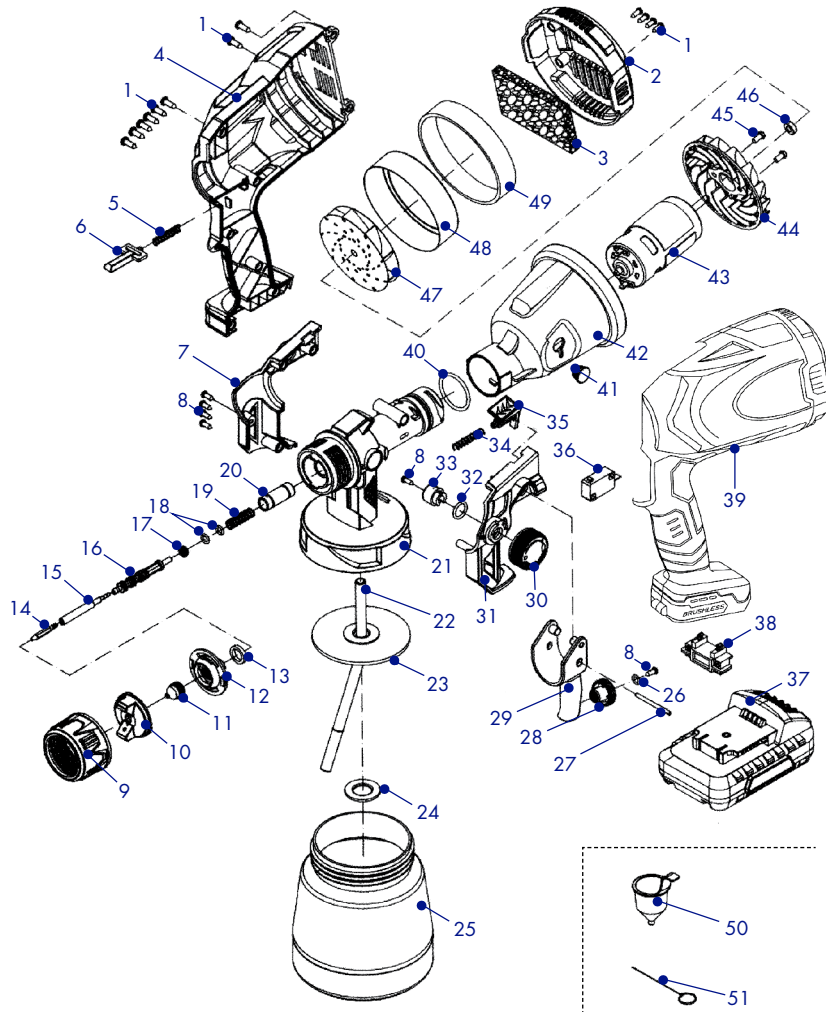

1. ST2.9*10SCRE	27. Short pin
2. Rear cover	28. Adjusting knob
3. Cotton filter	29. Trigger
4. Right cover	30. Spray knob
5. Switch plunger spring	31. Left side cover
6. Switch plunger	32. O-ring
7. Right side cover	33. Atomisation circle
8. ST3.5*10SCRE	34. Vent spring
9. Big nut	35. Lock catch
10. Spray ball	36. Microswitch
11. Spray nozzle	37. Battery pack
12. Barge board	38. Battery pack pin
13. Nozzle seal	39. Left cover
14. Needle	40. Gun-ring
15. Needle insert	41. Stopper
16. Needle seat	42. Motor cover
17. Bowl seals	43. 550 Motor
18. O-ring	44. Wind mill
19. 22 Needle spring	45. M4*8SCRE
20. Needle set	46. Motor gasket
21. Gun	47. Wind leaf
22. Pipette	48. Wind cover
23. Cup-ring	49. Damping ring
24. Suction pipe splint	50. Funnel
25. Cup	51. Pin
26. 03 Flat gasket	

4. OPERATING INSTRUCTIONS

Please read the following important information carefully.

4.1 PREPARING THE MATERIAL



IMPORTANT

Before spraying, it is important to prepare the material correctly. Failure to do so may result in shortening the service life of the unit and/or inferior spray quality.

MATERIAL	RUN-OUT TIME (SECONDS)
Oil enamel	25-60
Oil-based primer	30-60
Oil stain	No thinning required
Clear sealer	No thinning required
Polyurethane	No thinning required
Varnish	20-60
Lacquer sanding sealer	25-35
Lacquer	25-35
Automotive finishes	20-40
Latex	45-90



4.2 PREPARING AND FILLING THE SPRAYER

1. Unscrew the paint container from the spray gun

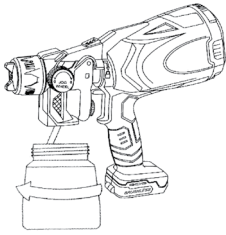

4. Remove the motor:

- Hold the gun with your hand and press the latch in the direction of the arrow
- Concurrently, hold the motor handle with your hand and rotate it counter-clockwise 90°
- Pull out to remove the motor from the gun

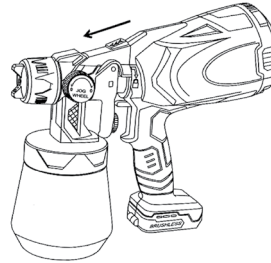

2. Adjust the suction tube

Suction
Tube

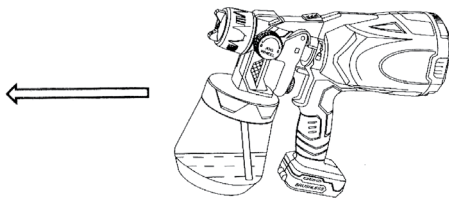

5. Connect gun body to motor:

- Hold the gun with your hand to align the slot on the motor and insert it
- Hold the motor handle with your hand and rotate your right hand counter-clockwise 90°
- When the gun and host are parallel, it is locked

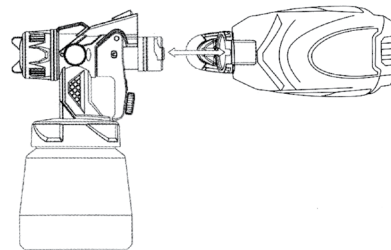

3. Pour material into container, making sure not to exceed 800 ml



4.3 ADJUSTING THE SPRAY LENGTH

Adjusting the spray length can reduce material wastage.

To adjust the spray length, turn the knob to adjust the round shape from vertical to horizontal.

To shorten the spray length, rotate counter-clockwise until it reaches the STOP position. This results in the largest spraying circle.

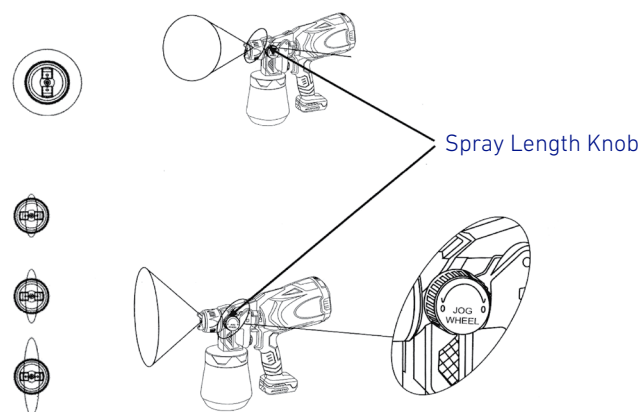

4.4 ADJUSTING THE PAINT VOLUME

To decrease the paint volume and decrease paint thickness, adjust the knob to the left.

To increase the paint volume and increase paint thickness, adjust the knob to the right.

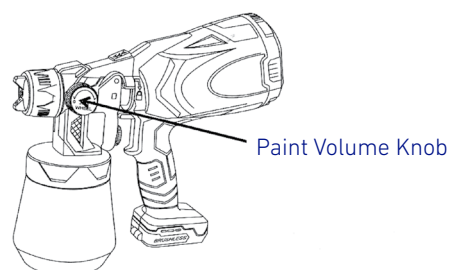

4.5 ADJUSTING THE SPRAY PATTERN

The gun spray pattern can be changed from a horizontal oval fan pattern to a round pattern by adjusting the nozzle.

To spray, open the power switch, pull the trigger, and the paint will spray from the nozzle.

Horizontal Oval Fan Pattern

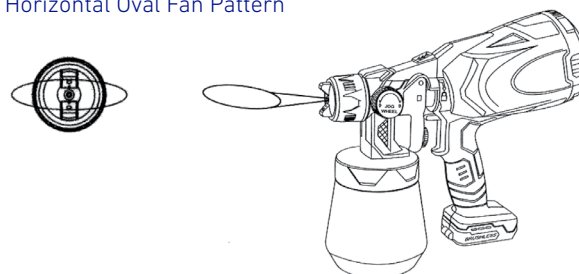

Round Pattern

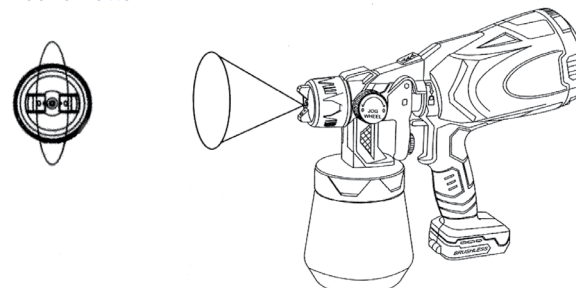

4.6 CORRECT METHOD OF SPRAYING

To ensure an even coat, maintain a smooth stroke and an even speed.

Do not flex your wrist while spraying.

✓ Correct Method of Spraying

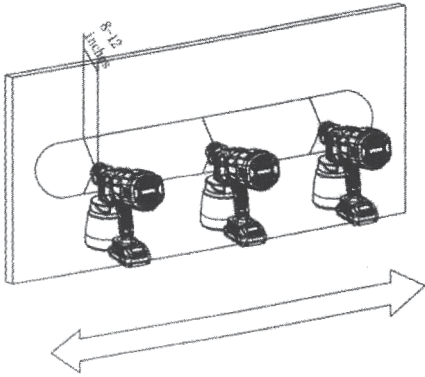

✗ Incorrect Method of Spraying

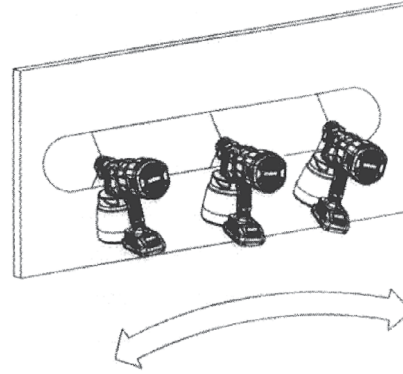

If spraying in an upward direction, the angled end of the suction tube should be pointing toward the rear of the gun. If spraying in a downward direction, the angled end of the suction tube should be pointing towards the front of the gun.

Spraying
Upwards

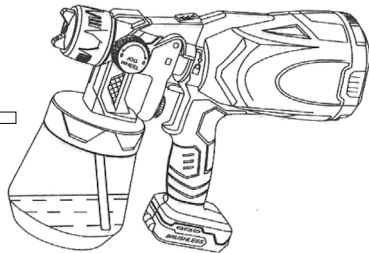

Spraying
Downwards



4.7 REPLACING THE NOZZLE AND NEEDLE

While disassembling the nozzle, pull the trigger first, then press and remove the nozzle. Rotate to remove the needle.

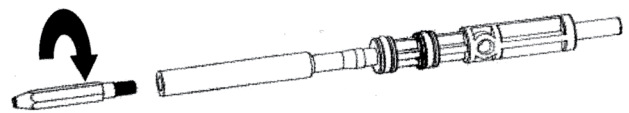
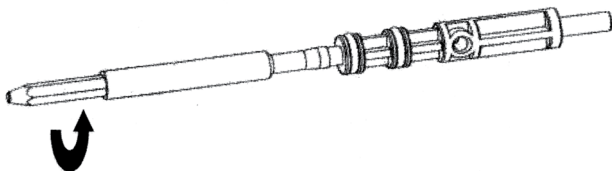

5. MALFUNCTIONS

Refer to the chart below for instructions on how to correct common malfunctions.

TYPE OF MALFUNCTION	POSSIBLE CAUSES	CORRECTIVE MEASURES
A. Little or no material flow	<ol style="list-style-type: none"> 1. Nozzle clogged 2. Suction tube clogged 3. Suction tube is loose 4. Material is too thick 5. Inconsistent paint flow 6. Container is loose 	<ol style="list-style-type: none"> 1. Clean the nozzle 2. Clean the suction tube 3. Tighten the suction tube 4. Check viscosity of material 5. Strain the paint 6. Tighten the container
B. Material is leaking	<ol style="list-style-type: none"> 1. Nozzle is loose 2. Nozzle is worn 3. Nozzle seal is worn 4. Material build-up in spray pattern dial and nozzle 	<ol style="list-style-type: none"> 1. Tighten the nozzle 2. Replace the nozzle 3. Replace the nozzle seal 4. Clean the nozzle
C. Atomisation is too coarse	<ol style="list-style-type: none"> 1. Viscosity of material is too high 2. Material volume is too large 3. Nozzle is clogged 4. Too little pressure build-up in container 	<ol style="list-style-type: none"> 1. Thin the material 2. Turn the adjustment screw to the right 3. Clean the nozzle 4. Tighten the container
D. Spray jet pulsates	<ol style="list-style-type: none"> 1. Material in container is running out 2. Material is too thick 	<ol style="list-style-type: none"> 1. Refill container 2. Check viscosity of material
E. Pattern runs or sags	<ol style="list-style-type: none"> 1. Too much material is being applied 	<ol style="list-style-type: none"> 1. Adjust the material flow or increase the movement of the spray gun
F. Too much over-spray	<ol style="list-style-type: none"> 1. Gun is too far away from object being sprayed 2. Too much material is being applied 	<ol style="list-style-type: none"> 1. Reduce distance from object being sprayed 2. Turn material volume setting to the right
G. Pattern is light and splotchy	<ol style="list-style-type: none"> 1. Spray gun is being moved too fast 	<ol style="list-style-type: none"> 1. Adjust the material flow or decrease the movement of the spray gun
H. Large 'cloud' of paint	<ol style="list-style-type: none"> 1. Spray gun is too close to the surface being sprayed 	<ol style="list-style-type: none"> 1. Move gun away from the surface and reduce paint flow

SELLEYS®

IF IT'S SELLEYS IT WORKS™

A Trusted Australian Brand Since 1939

Selleys is a subsidiary of
Nippon Paint (Singapore) Co. Pte Ltd
1 First Lok Yang Road, Jurong, Singapore 629728
Tel: 6265 5355 (Main Line)
www.selleys.com.sg