

SELLEYS®

IF IT'S SELLEYS IT WORKS™



SELLEYS S33 AIRLESS SPRAYPACK

OPERATING MANUAL

CONTENTS

- 1. SAFETY INFORMATION**
 - 1.1 General Safety Precautions
 - 1.2 Specific Safety Hazards and Precautions
 - 1.3 Earthing Instructions

- 2. COATINGS**
 - 2.1 Suitable Coatings
 - 2.2 Preparation of Coating Materials
 - 2.3 Viscosity
 - 2.4 2-component Coating Materials
 - 2.5 Coatings Containing Abrasive Materials

- 3. EQUIPMENT**
 - 3.1 Technical Data
 - 3.2 Main Components
 - 3.3 Component Identification

- 4. OPERATING INSTRUCTIONS**
 - 4.1 Setup
 - 4.2 Startup
 - 4.3 Pressure Relief Procedure
 - 4.4 Installation of Spray Tip
 - 4.5 Clearing Spray Tip Clogs
 - 4.6 Before Spraying the Coating Material
 - 4.7 Method of Spraying
 - 4.8 Handling the High-Pressure Hose
 - 4.9 In Case of Interrupted Operation

- 5. CLEANING AND MAINTENANCE**
 - 5.1 Cleaning and Shutting Down
 - 5.2 Cleaning the Airless Spray Gun
 - 5.3 Disassembly of the Gun Filter
 - 5.4 Assembly of the Gun Filter

- 6. MALFUNCTIONS**

- 7. SERVICING AND REPAIRS**
 - 7.1 Routine Checking
 - 7.2 Repairs to the Packings

- 8. CONNECTION GUIDE**

- 9. PARTS AND ASSEMBLY**

1. SAFETY INFORMATION

Please read the following important information carefully.

The following symbols indicate specific types of safety hazards.



Indicates a potential hazard that may cause **serious injury to the operator or loss of life.**



Indicates a potential hazard that may cause **minor injury to the operator or to the equipment.**



Indicates **important information.**



WARNING

This unit is capable of extremely high spraying pressures that can cause serious and/or minor injury by injection and extensive damage to property.



IMPORTANT

All replacement parts and accessories should **ONLY** be purchased from SELLEYS or an authorised distributor of SELLEYS equipment. Servicing should **ONLY** be carried out by SELLEYS or an authorised distributor of SELLEYS equipment. If these conditions are not met, the operator assumes all liability for injury and property damage arising from the use of this unit.

1.1 GENERAL SAFETY PRECAUTIONS

✗ NEVER

- use the spray gun without the safety guard in place
- operate faulty units or use faulty accessories
- attempt to repair a damaged hose
- leave this equipment unattended
- move the unit when it is running
- spray outside on windy days

✓ ALWAYS

- ensure that this unit is properly earthed
- ensure that the power cord, air hose and spray hoses are optimally routed to minimise slip, trip and fall hazards
- immediately and thoroughly clean up all material and solvent spills to prevent slip hazards
- follow the material manufacturer's instructions for safe handling of coating materials
- unplug the cord from the outlet before cleaning, maintaining or repairing this unit
- keep the power cord plug in sight during use to prevent accidental shutdowns and startups
- wear ear protection to protect against possible hearing loss from the noise produced by this unit, which can exceed 85 dB(A)
- keep this unit out of reach of children, unqualified adults and animals
- comply with local codes regarding ventilation, fire prevention, and operation

1.2 SPECIFIC SAFETY HAZARDS AND PRECAUTIONS

SAFETY PRECAUTIONS TO PREVENT INJECTION INJURY



WARNING

Serious risk of injection injury. This equipment produces a high-pressure stream that can pierce the skin and subcutaneous tissues, resulting in severe injury and even possible amputation.



IMPORTANT

The maximum operating range of the unit is 220 bar (3200 PSI) fluid pressure.

✗ NEVER

- put your fingers, hands or any other parts of your body into the spray jet
- point the spray gun at yourself or anyone else (including animals)
- allow the fluid stream to come into contact with any part of your body
- allow any leak in the fluid hose to come into contact with any part of your body
- put your hand in front of the gun

NOTE: Gloves do not provide full protection against injection injury.

- use a spray gun without both a working trigger lock and trigger guard in place

✓ ALWAYS

- ensure that the gun trigger is locked, the fluid pump is shut off, and all pressure is released before servicing, cleaning the nozzle holder, changing spray tip, or leaving the unit unattended

NOTE: Turning off the engine will not release the pressure. The PRIME/SPRAY valve or pressure bleed valve must be turned to their appropriate positions to relieve system pressure.

- ensure that the nozzle holder remains in place during spraying
- remove the spray tip before flushing or cleaning the system
- carefully check the paint hose for leaks before each use, as even small leaks can cause injection injury
- ensure that all accessories, including but not limited to spray tips, guns, extensions and hose, are rated at or above the maximum operating pressure range of the sprayer



IMPORTANT MEDICAL INFORMATION

Injection injury is a traumatic injury that requires immediate medical attention. Any laceration of the skin, no matter how minor it seems, should not be treated as a simple cut. Fully inform the medical team about the coatings or solvents involved, as some coatings are toxic when injected directly into the bloodstream. For serious injuries, a plastic surgeon or reconstructive hand surgeon should be consulted.

SAFETY PRECAUTIONS TO PREVENT EXPLOSIONS AND FIRE



WARNING

This equipment produces a high-pressure stream that can pierce the skin and subcutaneous tissues, resulting in severe injury and even possible amputation.

✗ NEVER

- use plastic drop cloths or enclose the spray area with plastic sheets, as plastic can cause static sparks
- smoke in the spray area
- use any materials with a flashpoint lower than 21 °C (70 °F)

NOTE: Flashpoint is the temperature at which a fluid can produce sufficient vapours to ignite.

✓ ALWAYS

- ensure that the spray area is well-ventilated to prevent the build-up of flammable vapours
- avoid all ignition sources such as static electricity sparks, electrical appliances, flames, pilot lights, hot objects, and sparks from connecting and disconnecting power cords and/or working light switches
- flush the unit into a separate metal container, at the lowest possible pump pressure and with the spray tip removed
- hold the gun firmly against the side of the container to prevent static sparks
- have a fire extinguisher nearby
- place the sprayer at a minimum of 6.1 metres (20 feet) from the surface to be sprayed, extending the hose if necessary. Since flammable vapours are often heavier than air, the floor area must be well ventilated. The pump contains arcing parts that emit sparks, which can ignite vapours.
- ensure that the equipment and objects in and around the spray area are properly grounded to prevent static sparks
- ensure that you are using a conductive or earthed high pressure hose
- ensure that the gun is earthed through the hose connection
- ensure that the power cord is connected to a grounded circuit
- ensure that the unit is connected to an earthed object such as a water pipe, steel beam, or other electrically earthed surface, via the green earthing wire
- strictly follow the material and solvent manufacturer's warnings and instructions, and read the coating material's MSDS (Material Safety Data Sheet) and technical information before use

SAFETY PRECAUTIONS TO PREVENT EXPLOSIONS DUE TO INCOMPATIBLE MATERIALS



WARNING

Serious risk of explosions due to incompatible materials. Accidental explosions due to incompatible materials can cause serious injury and/or extensive damage to property.

✗ NEVER

- use materials that contain bleach or chlorine
- use halogenated hydrocarbon solvents such as methylene chloride and 1,1,1-trichloroethane

NOTE: These substances are not compatible with aluminium and may cause an explosion. If you are in any doubt over a material's compatibility with aluminium, check with your coating supplier.

SAFETY PRECAUTIONS TO PREVENT HARM FROM TOXIC VAPOURS



WARNING

Vapours from paints, solvents, insecticides, and other materials can be harmful in the event of inhalation or contact with any part of the body. Symptoms include severe nausea, fainting and poisoning.

✓ ALWAYS

- use a respirator or mask
- wear protective eyewear
- wear protective clothing

SAFETY PRECAUTIONS TO PREVENT HARM FROM MOVING PARTS



WARNING

Moving parts can pinch, cut or amputate fingers and other body parts. Furthermore, equipment can start without warning.

✓ ALWAYS

- keep clear of moving parts
- follow the **Pressure Relief Procedure** and disconnect all power sources before checking, moving or servicing the equipment

✗ NEVER

- operate equipment with protective guards or covers removed

1.3 EARTHING INSTRUCTIONS

✗ NEVER

- operate this unit unless you are sure that it has been properly earthed
- modify the earthing plug
- use a 3-to-2 adapter with this equipment

✓ ALWAYS

- ensure that the earthing plug is plugged into an outlet that has been properly installed and earthed in accordance with local codes
- seek the advice of a qualified electrician if you need a new outlet installed to fit the earthing plug, do not fully understand these earthing instructions, or are unsure as to whether this unit is properly earthed
- if required, use only a 3-wire extension cord with a grounding plug and a grounding receptacle that accepts the plug on this equipment, and a minimum AWG (2.5 mm²) to carry the current that this equipment draws

Conductor Size		Length
AWG (American Wire Gauge)	Metric	Maximum
1 ²	2.5 mm ²	15 m (50 ft)



WARNING

Incorrect installation of the earthing plug can result in electric shock. If you need to repair or replace the cord or plug, do not connect the green earthing wire to either blade terminal.



IMPORTANT

The wire with insulation, which has a green outer surface with or without yellow stripes, is the earthing wire. It must be connected to the earthing pin.

Use of an undersized cord causes a drop in line voltage, loss of power and overheating.

A list of the materials used in the construction of this unit is available upon request for the purpose of determining compatibility with coating materials.

2. COATINGS

Please read the following important information carefully.

2.1 SUITABLE COATINGS

This unit is suitable for the application of:

- dilutable lacquers and paints
- coatings containing solvents
- 2-component coating materials
- dispersions
- latex paints

Do not spray coatings other than those listed above without the prior approval of SELLEYS or the authorised distributor of this unit.

2.2 PREPARATION OF COATING MATERIALS

Always filter and stir the coating material before application. To prevent downtime, make sure that no air bubbles are introduced, especially when stirring the coating material with motor-driven agitators.

2.3 VISCOSITY

This unit is able to process highly viscous coating materials of up to around 20,000 mPa-s.

Highly viscous coating materials can be diluted according to the manufacturer's instructions.

2.4 2-COMPONENT COATING MATERIALS

When preparing two-component coating materials for spraying, follow the manufacturer's instructions and do not skimp on the mixing/processing time. While the components are processing, thoroughly rinse and clean the unit with suitable cleaning agents.

2.5 COATINGS CONTAINING ABRASIVE MATERIALS

Coatings that contain sharp-edged aggregates and additional materials cause intense wear and tear on this unit's parts, including its valves, high-pressure hose, spray gun and spray tip.

Use of abrasive coatings may shorten the working life of this unit.

3. EQUIPMENT

Please read the following important information carefully.

3.1 TECHNICAL DATA

Dimensions (L x W x H)	680 x 640 x 900 mm
Weight	62 kg
Motor output	3.3 kW
Flow rate	4.5 L/min
Max. nozzle size	0.033"
Max. operating pressure	220 bar
Voltage	220 V / 50 Hz
Max. temperature of coating material	43 °C
Max. viscosity	25,000 mPa-s
Max. sound pressure level	80 dB
High pressure hose	DH 6 mm, 15 m

3.2 MAIN COMPONENTS

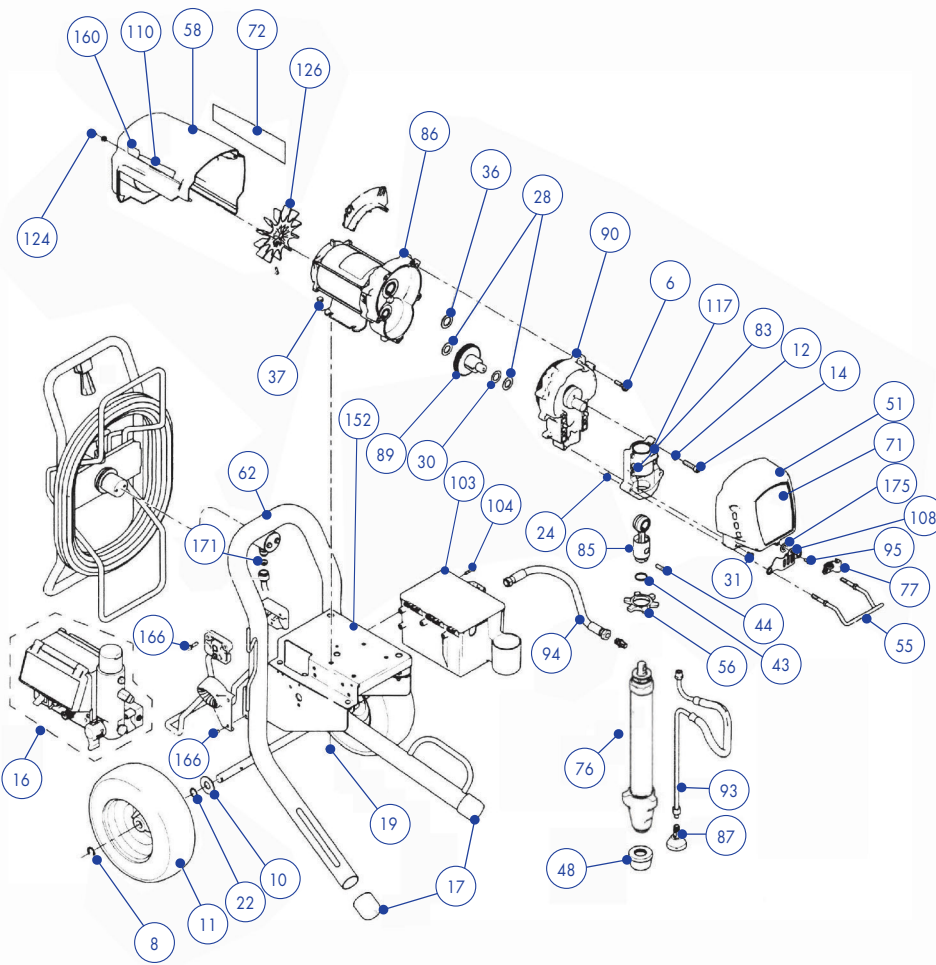

NO.	NAME	QUANTITY
6	SHCS	5
8	Protection clip	2
10	Spacer ring	2
11	Pneumatic tyre	2
12	Washer	4
14	Screw cap	4
16	DESC-Control assembly	1
17	Trolley frame cap	2
19	Hex nuts, flange head	8
22	Washer, wave spring	2
24	Locking nut	2
28	Spacer ring	2
30	Spacer ring	1
31	SHCS	4
36	Spacer ring	1
37	Hex nut	4
43	Fixed spring	1
44	Pin	1
48	Suction filter	1
51	Front cover	1
55	Shelf	1
56	Fixed nut	1
58	Rear cover	1

NO.	NAME	QUANTITY
62	Trolley frame	1
76	Suction tube	1
77	Drain line	1
83	Bearing housing	1
84	Motor	1
85	Connecting rod	1
87	Thread deflector	1
89	Gear combination	1
90	Drive housing	1
90a	Spacer ring	1
93	Return hose	1
94	Fluid outlet	1
95	SHCS	1
103	Toolbox	1
104	SHCS	1
107	SHCS	4
108	Oil reservoir	1
124	Screw	2
126	Fan	1
152	Frame assembly	1
166	SHCS	2
171	Seal	2
175	Spacer ring	1

3.3 COMPONENT IDENTIFICATION

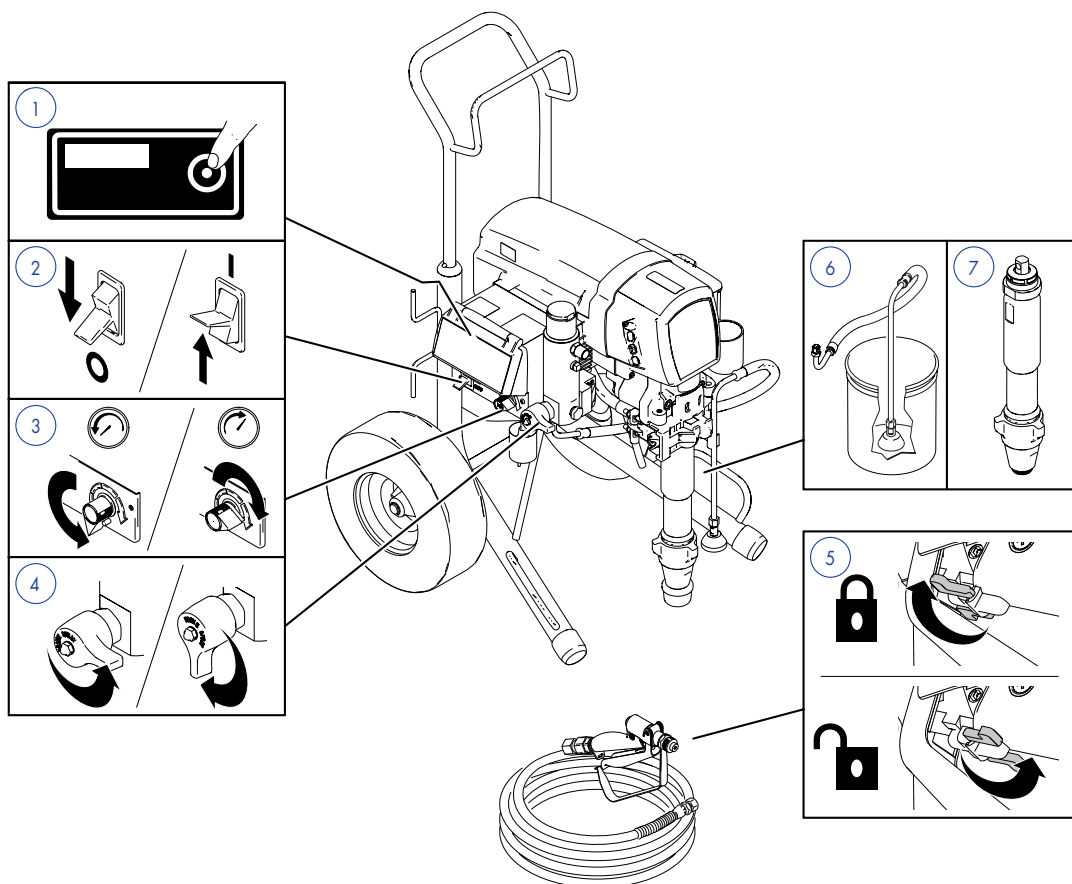

- | | |
|---|-----------------------|
| 1 | DESC-Control display |
| 2 | ON/OFF switch |
| 3 | Pressure control knob |
| 4 | Relief valve |

- | | |
|---|------------------|
| 5 | Gun trigger lock |
| 6 | Return hose |
| 7 | Suction tube |

4. OPERATING INSTRUCTIONS

Please read the following important information carefully.

4.1 SETUP



WARNING

Serious risk of explosions due to incompatible materials. Accidental explosions due to incompatible materials can cause serious injury and/or extensive damage to property.

1. Connect 15 m (50 ft) airless hose to sprayer and tighten securely

NOTE: Remove adapter fitting for 13 mm (1/2 in.) hose.

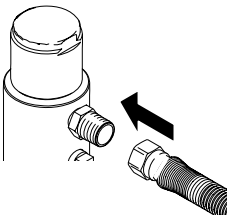

2. Install airless hose to the fluid inlet of the spray gun

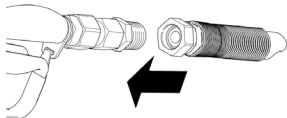

3. Tighten securely

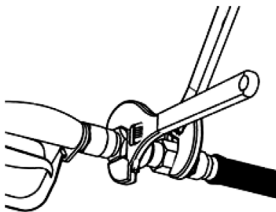

4. Remove inlet strainer and suction filter when spraying plaster materials

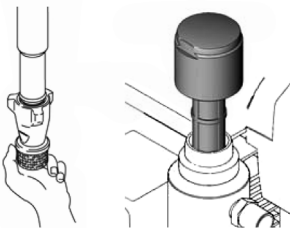

5. Fill throat packing nuts with separating oil to prevent premature packing wear. Do this each time you spray.

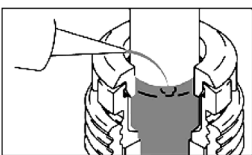

6. Turn power OFF

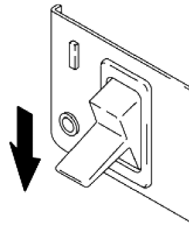

7. Plug power supply cord into a properly grounded electrical outlet

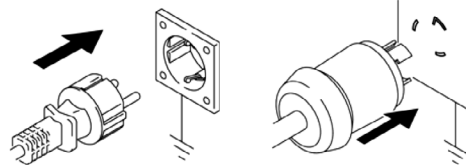

8. Turn the relief valve to "PRIME" position

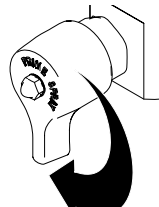

9. Place suction tube into a metal pail partially filled with residual water. Attach ground wire to pail and to true earth ground (see **Earthing Instructions**). Perform steps 1 – 5 of **Startup** to flush out storage oil shipped in sprayer. Use water to flush water-based paint and appropriate solvent to flush oil-based paint and storage oil.

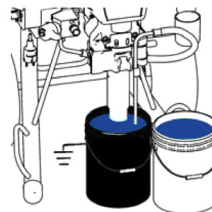

4.2 STARTUP



WARNING

Serious risk of explosions due to incompatible materials. Accidental explosions due to incompatible materials can cause serious injury and/or extensive damage to property.

1. Turn pressure control knob to "minimum"

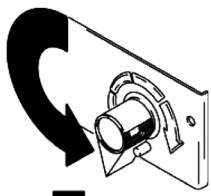

2. Turn power ON

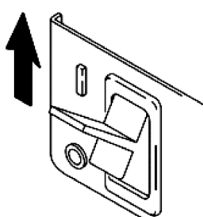

3. Increase pressure to start motor and allow fluid to circulate through return hose for 15 seconds. Decrease pressure control knob to minimum.

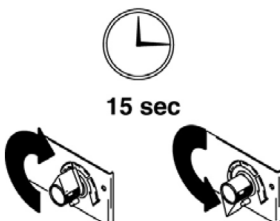

4. Turn relief valve to "SPRAY" position



5. Trigger the spray gun, whilst increasing the pressure control knob, if necessary

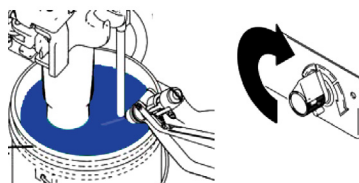

6. Inspect for leaks. If leaks occur, perform **Pressure Relief Procedure**. Tighten fittings. **Perform Startup** steps 1 - 5. If no leaks, proceed to step 6.

7. Place suction tube into the container of material

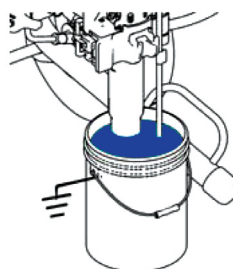

8. Trigger gun again into flushing pail until paint appears. Move gun to paint pail and trigger for 20 seconds. Set gun safety ON. Assemble spray tip and nozzle holder.

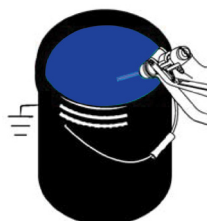

4.3 PRESSURE RELIEF PROCEDURE

Follow these steps carefully.

1. Immerse the suction tube and return hose in a container, filled with a suitable cleaning agent
2. Turn the pressure control knob counter-clockwise to minimum pressure
3. Turn the relief valve and set to "PRIME" position
4. Wait until the cleaning agent discharges from the return hose
5. Turn the relief valve and set to "SPRAY" position
6. Pull the trigger of the spray gun
7. Spray the cleaning agent from the unit into a container

4.4 INSTALLATION OF SPRAY TIP

1. Insert spray tip into nozzle holder (arrow points forward)

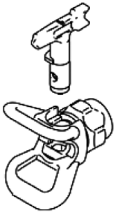

2. Insert nozzle seal (curved side in) into housing

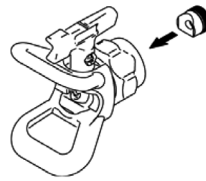

3. Install assembled spray tip and nozzle holder in spray gun

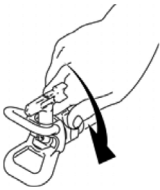

4. Install appropriate spray tip for your material

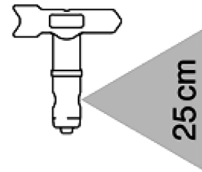

4.5 CLEARING SPRAY TIP CLOGS



WARNING

Serious risk of explosions due to incompatible materials. Accidental explosions due to incompatible materials can cause serious injury and/or extensive damage to property.

1. Release trigger, put safety ON. Rotate Spray Tip. Take safety OFF. Trigger gun to clear clog. Never point gun at your hand or into a rag!

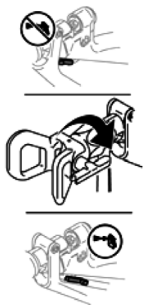

2. Put safety ON. Return Spray Tip to original position. Take safety OFF and continue spraying.

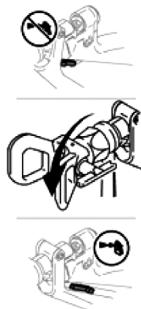

4.6 BEFORE SPRAYING THE COATING MATERIAL

Follow these steps carefully.

1. Turn the pressure control knob counter-clockwise to minimum pressure
2. Turn the relief valve and set to "PRIME" position
3. Switch the unit ON
4. Wait until the coating material discharges from the return hose
5. Turn the relief valve and set to "SPRAY" position
6. Trigger the spray gun and spray into a container until the coating material exits the spray gun continuously
7. Increase the pressure by slowly turning the pressure control knob clockwise
8. Check the spray pattern and increase the pressure until the desired atomisation is attained
9. The unit is ready to spray

4.7 METHOD OF SPRAYING



WARNING

Never trigger the gun unless the spray tip is completely turned to either the spray or the unclog position. Always engage the gun trigger lock before removing, replacing or cleaning the spray tip.

Follow these steps carefully.

1. Ensure that the nozzle holder is in place
2. Trigger the gun AFTER starting the stroke

3. To ensure even application:

- keep your arm moving at a constant speed
- keep the spray gun perpendicular to the surface
- keep the spray gun at a constant distance of 25 to 30 cm from the surface
- overlap each stroke by about 30%

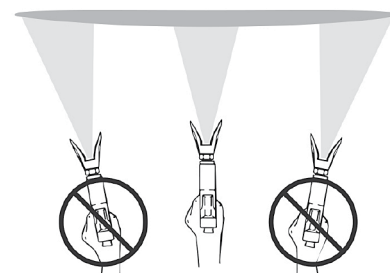
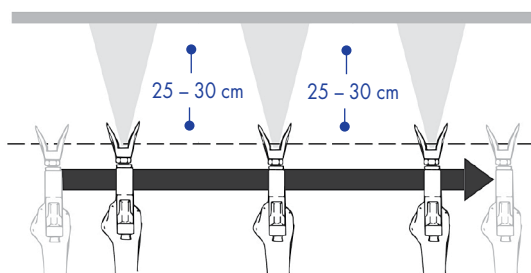

4. Release the gun BEFORE ending the stroke

NOTE: Gloves do not provide full protection against injection injury.



IMPORTANT

If very sharp edges or streaks appear on the coated surface, increase the operating pressure or dilute the coating material.

4.8 HANDLING THE HIGH-PRESSURE HOSE

Avoid sharp bending or kinking of the high-pressure hose. The smallest bending radius amounts to about 20 cm.

Do not drive over the high-pressure hose, and avoid contact with sharp objects and edges.



WARNING

Defective high-pressure hoses can leak and cause serious injection injury. Replace defective high-pressure hoses immediately. Never attempt to repair a defective high-pressure hose.

4.9 IN CASE OF INTERRUPTED OPERATION

Follow these steps carefully.

1. Turn the relief valve and set to "PRIME" position
2. Switch the unit OFF
3. Turn the pressure control knob counter-clockwise to minimum pressure
4. Pull the trigger of the spray gun in order to release the pressure from the high-pressure hose and spray gun
5. Secure the spray gun
6. Leave the suction tube (or the suction hose and return hose) immersed in the coating material, or in a cleaning agent



IMPORTANT

If a fast-drying or two-component coating material is used, ensure that the unit is rinsed with a suitable cleaning agent within the processing time.

5. CLEANING AND MAINTENANCE

Please read the following important information carefully.

5.1 CLEANING AND SHUTTING DOWN



WARNING

Serious risk of explosions due to incompatible materials. Accidental explosions due to incompatible materials can cause serious injury and/or extensive damage to property.

A. Turn power OFF. Wait 30 seconds for power to dissipate.

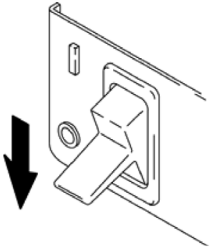

1. Do Steps A – D first. Remove suction tube from paint and place in flushing fluid.

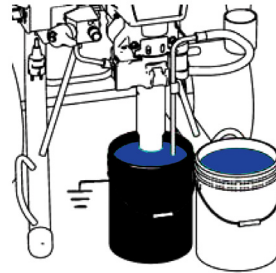

B. Lock gun trigger safety. Remove nozzle holder and spray tip.

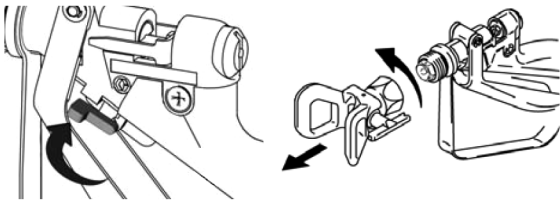

2. Unscrew the filter cap, and clean the strainer filter.

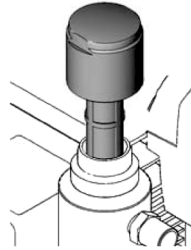

C. Turn the pressure control knob to minimum, and trigger the gun to release pressure

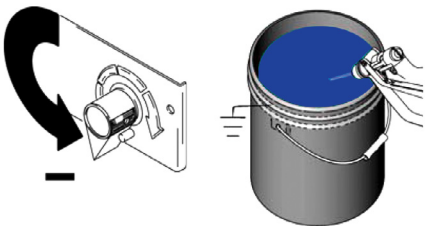

3. Switch power ON, and turn the relief valve to "SPRAY" position

NOTE: Use water for water-based material and appropriate solvent for oil-based material.

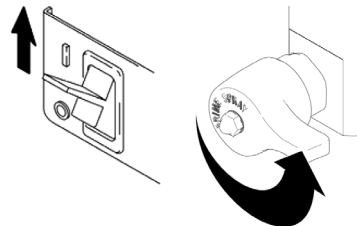

D. Put the return the return hose in a container and turn the relief valve to "PRIME" position

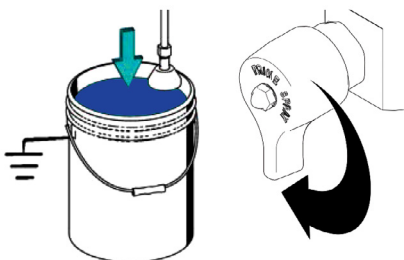

4. Increase pressure slowly. Hold gun against the paint container. Unlock the trigger, and flush the gun until the flushing fluid appears.

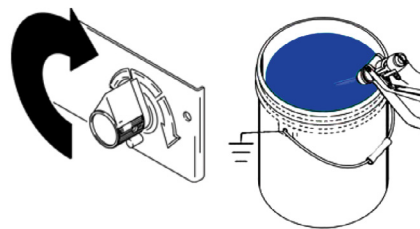

5. Move gun to waste pail, hold gun against pail, trigger gun to thoroughly flush system. Release trigger and put trigger safety ON.

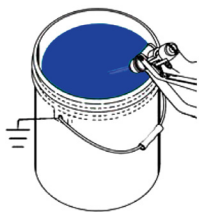

6. Turn the relief valve to "PRIME" position and allow the flushing fluid to circulate and clean the return hose

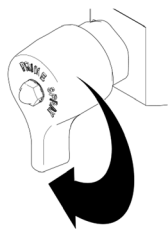

7. Remove the suction tube and allow the unit to run and drain the flushing fluid



8. Turn the relief valve to "SPRAY" position. Trigger the gun into the flushing pail. Switch OFF power.

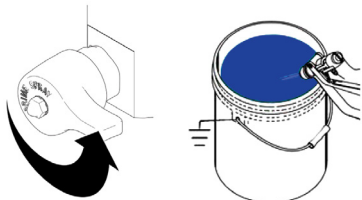

9. Turn the relief valve to "PRIME" position, and ensure the pressure control knob is set to "minimum". Unplug the unit from the power source.

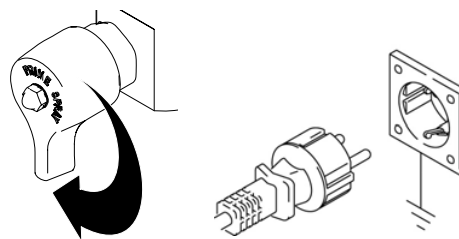

10. Remove filters from gun and sprayer, if installed. Clean and inspect. Install filters.

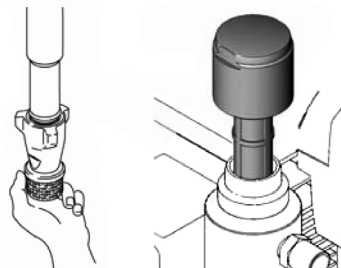

11. If flushing with water, flush again with mineral spirits, or a suitable product, to leave a protective coating to prevent freezing or corrosion



12. Wipe sprayer, hose and gun with a rag soaked in water or mineral spirits



IMPORTANT

The container must be earthed in case of coating materials that contain solvents.

5.2 CLEANING THE AIRLESS SPRAY GUN

Follow these steps carefully.

1. Rinse the airless spray gun with a sufficient amount of a suitable cleaning agent
2. Thoroughly clean the spray tip with a sufficient amount of a suitable cleaning agent until all unused coating material has been removed
3. Thoroughly clean the outside of the airless spray gun

5.3 DISASSEMBLY OF THE GUN FILTER

Follow these steps carefully.

1. Pull the protective guard (Figure 1.1) forward with moderate force
2. Unscrew the grip (1.2) from the gun housing and remove the gun filter (1.3)



IMPORTANT

Replace the gun filter if it is clogged or faulty.

5.4 ASSEMBLY OF THE GUN FILTER

Follow these steps carefully.

1. Place the gun filter (Figure 1.3) with the long cone pointing up into the gun housing
2. Screw the grip (1.2) into the gun housing and tighten
3. Slot in the protective guard (1.1)

Figure 1

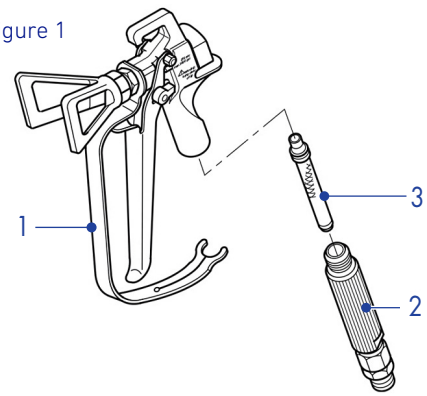

6. MALFUNCTIONS

Refer to the chart below for instructions on how to correct common malfunctions.

TYPE OF MALFUNCTION	POSSIBLE CAUSES	CORRECTIVE MEASURES
A. Unit does not start	<ol style="list-style-type: none"> 1. No voltage applied 2. Pressure setting is too low 3. ON/OFF switch is defective 	<ol style="list-style-type: none"> 1. Check voltage supply 2. Turn up pressure control knob 3. Replace
B. Unit does not draw in material	<ol style="list-style-type: none"> 1. Relief valve is set to SPRAY 2. Filter projects over the fluid level and sucks air 3. Filter is clogged 4. Suction hose/suction tube is loose, i.e., the unit is sucking in outside air 	<ol style="list-style-type: none"> 1. Set relief valve to PRIME (circulation) 2. Refill the coating material 3. Clean or replace the filter 4. Clean connecting points. Replace O-rings if necessary. Secure suction hose with retaining clip
C. Unit draws in material, but the pressure does not build up	<ol style="list-style-type: none"> 1. Spray tip is heavily worn 2. Spray tip is too large 3. Pressure setting is too low 4. Filter is clogged 5. Coating material flows through the return hose when the relief valve is in the SPRAY position 6. Packings are sticky or worn 7. Valve balls are worn 8. Valve seats are worn 	<ol style="list-style-type: none"> 1. Replace 2. Select a smaller spray tip 3. Turn pressure control knob clockwise to increase pressure 4. Clean or replace the filter 5. Remove and clean or replace relief valve 6. Remove and clean or replace packings 7. Remove and replace valve balls 8. Remove and replace valve seats
D. Coating material exits at the top of the fluid section	<ol style="list-style-type: none"> 1. Upper packing is worn 2. Piston is worn 3. Incorrect high-pressure hose type 	<ol style="list-style-type: none"> 1. Remove and replace packing 2. Remove and replace piston 3. Only use original high-pressure hoses
E. Increased pulsation at the spray gun	<ol style="list-style-type: none"> 1. Incorrect high-pressure hose type 2. Spray tip is worn or too large 3. Pressure is too high 	<ol style="list-style-type: none"> 1. Only use original-high pressure hoses 2. Replace spray tip 3. Turn pressure control knob to a lower number
F. Poor spray pattern	<ol style="list-style-type: none"> 1. Spray tip is too large for the coating material being sprayed 2. Pressure setting incorrect 3. Volume is too low 4. Coating material viscosity is too high 	<ol style="list-style-type: none"> 1. Replace spray tip 2. Turn pressure control knob until a satisfactory spraying pattern is achieved 3. Clean or replace all filters 4. Thin out according to the manufacturer's instructions
G. Unit loses power	<ol style="list-style-type: none"> 1. Pressure setting is too low 	<ol style="list-style-type: none"> 1. Turn pressure control knob clockwise to increase

7. SERVICING AND REPAIRS

Please read the following important information carefully.

Repairs to the Relief Valve, Inlet and Outlet Valve, and Packings should only be carried out by a qualified electrician or an authorised distributor of SELLEYS equipment.

Remember to get this unit serviced annually (or more often in the case of heavy usage) by an authorised distributor of SELLEYS equipment.



WARNING

Always unplug the power plug from the outlet before commencing any repair works on the unit.

7.1 ROUTINE CHECKING

Prior to every use/on a weekly basis:

- check the high-pressure hoses and the device connecting the line and plug for damage and wear
- check the inlet valve, outlet valve and filter for damage and wear
- check the high-pressure hose for any notches or bulges, especially around the transitions in the fittings. You should be able to easily turn the union nuts, without using force.

7.2 REPAIRS TO THE PACKINGS

To disassemble the pump, follow these steps carefully.

1. Remove packing nut (102)

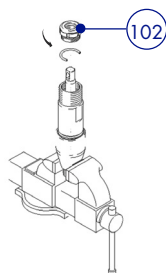

2. Unscrew intake valve from cylinder

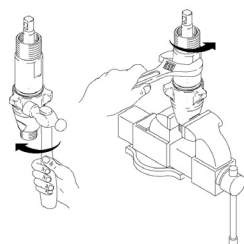

3. Disassemble intake valve. Clean and inspect O-ring (122).

NOTE: A pick may be required to remove O-ring.

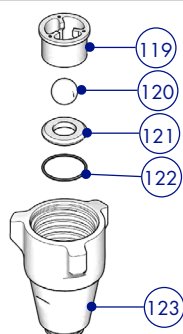

4. Tap piston rod out of cylinder with a hammer or flip over and tap piston rod out against a bench

NOTE: Sleeve may come out of cylinder with piston.

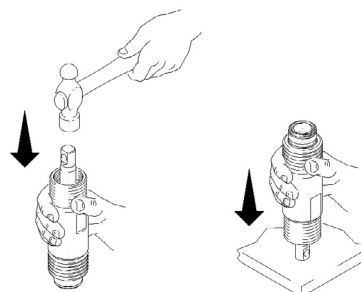

5. Remove piston rod from sleeve, or remove sleeve from cylinder. Remove O-ring from top of sleeve (or from inside of cylinder if O-ring did not come out with sleeve).

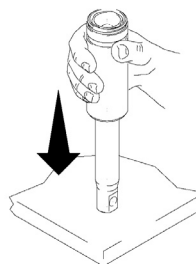



WARNING

Component rupture hazard. To reduce the risk of serious injury from pressurised fluid, do not clean or wipe the piston valve threads. Cleaning the piston valve threads could destroy the special sealing patch and cause the piston valve to come loose during operation.

6. Unscrew piston valve from piston rod. Clean and inspect parts. The piston has a special thread locking/sealing patch. Do not remove the patch. The patch allows four disassembly/assembly procedures before it is necessary to apply thread sealant to the threads.

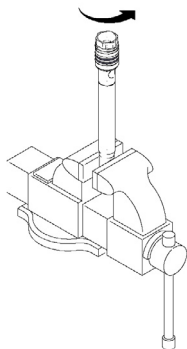

7. Remove lower seals (113 & 114) and lower gland (116) from piston rod

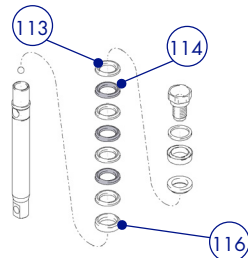

8. Remove upper seals (105 & 106) and upper gland from cylinder (107)

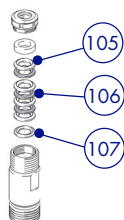

To assemble the pump, follow these steps carefully.

1. Soak all leather packings in cleaning agent for 1 hour minimum prior to assembly. Stack positioning sleeve (112) on piston rod. Alternately stack (113) and (114) (note orientation) on piston rod. Install lower gland (116). Install backup U-cup (115) (note orientation) on steel ball seat (118).

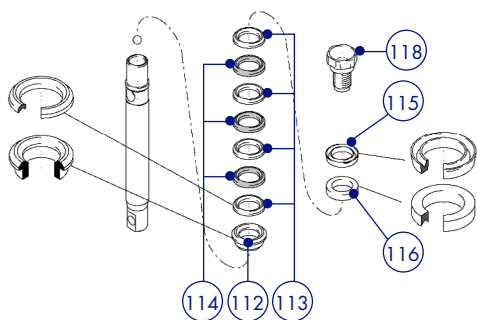

2. Install small ball (117) in piston rod. If thread sealant is applied, ensure none of the sealant gets onto the small ball.

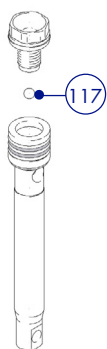

3. Tighten piston valve to piston rod

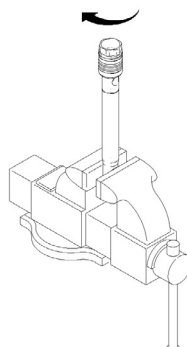

4. Soak all leather seals in a cleaning agent for one hour. Place upper gland (107) in cylinder. Alternately stack upper leather seals (106) (note orientation). Place the positioning sleeve (104) on top of the cylinder.

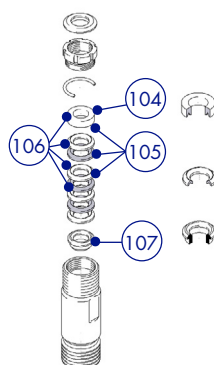

5. Install the guide sleeve (101) onto the packing nut (102), and install the packing nut into the cylinder

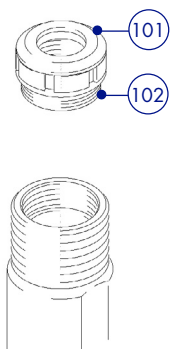

6. Grease piston packings

NOTE: Do not slide piston assembly into top of sleeve as this may damage piston packing.

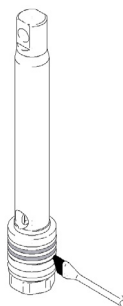

7. Slide piston rod into the bottom of cylinder

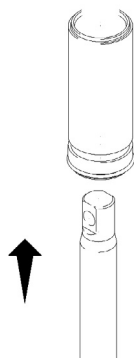

8. Grease the piston rod

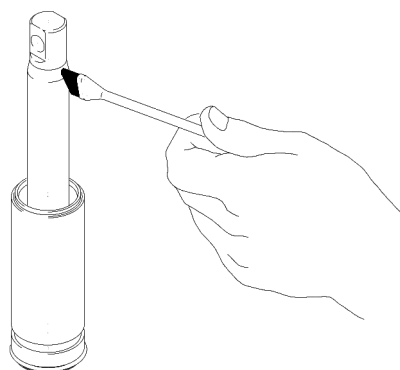

9. Assemble the O-ring (122), big ball seat (121) and big ball (120), into the pump assembly (123)

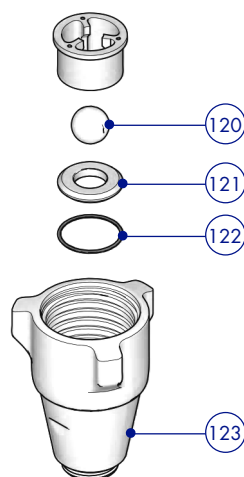

10. Install intake valve on cylinder. If a wrench is used, torque as follows.

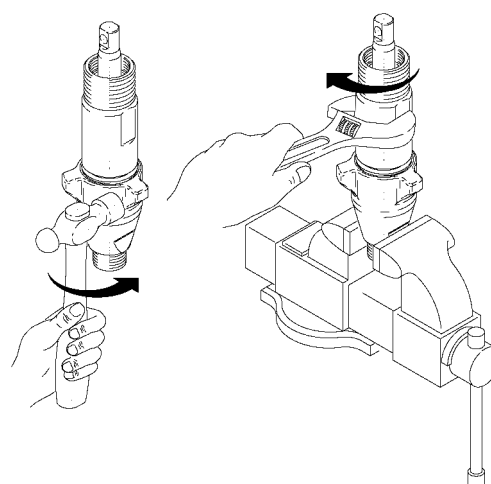

11. Torque seal and packing nut (102) down

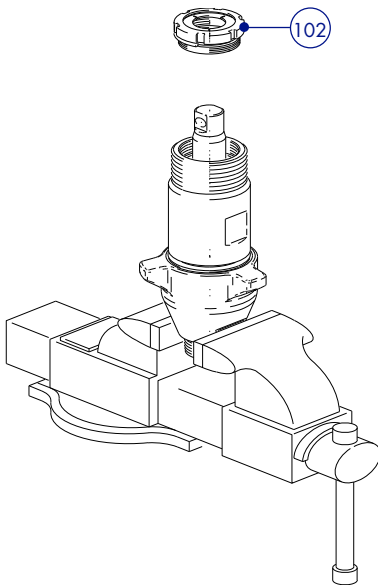

12. Then tighten packing nut down until leakage stops or lessens

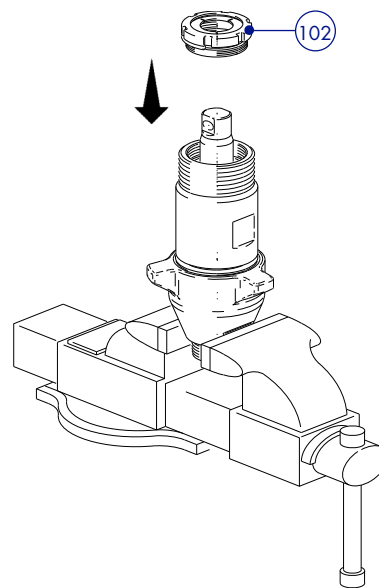

8. CONNECTION GUIDE

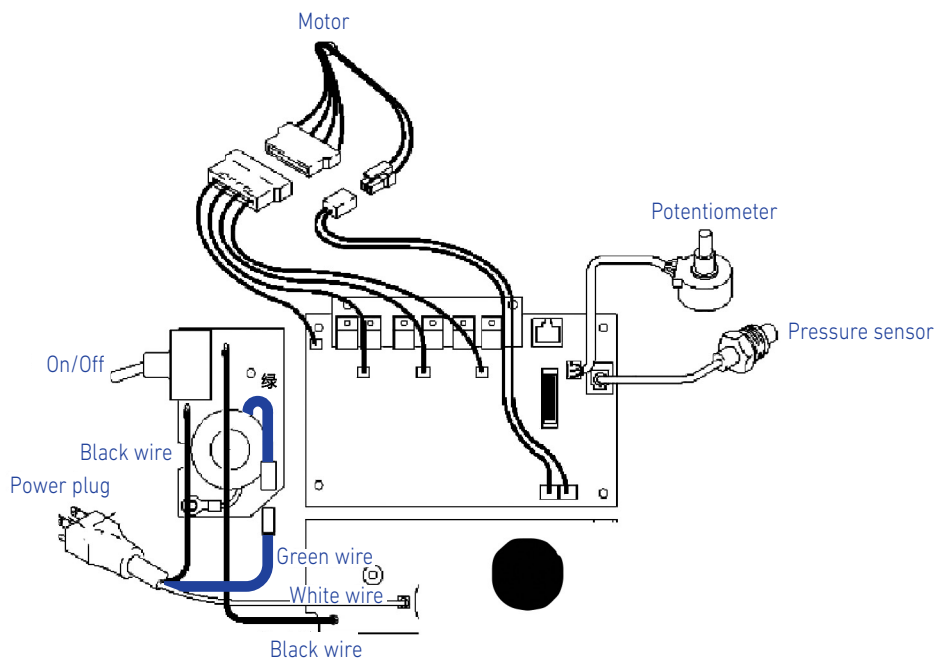

9. PARTS AND ASSEMBLY

Please examine the following diagrams carefully.

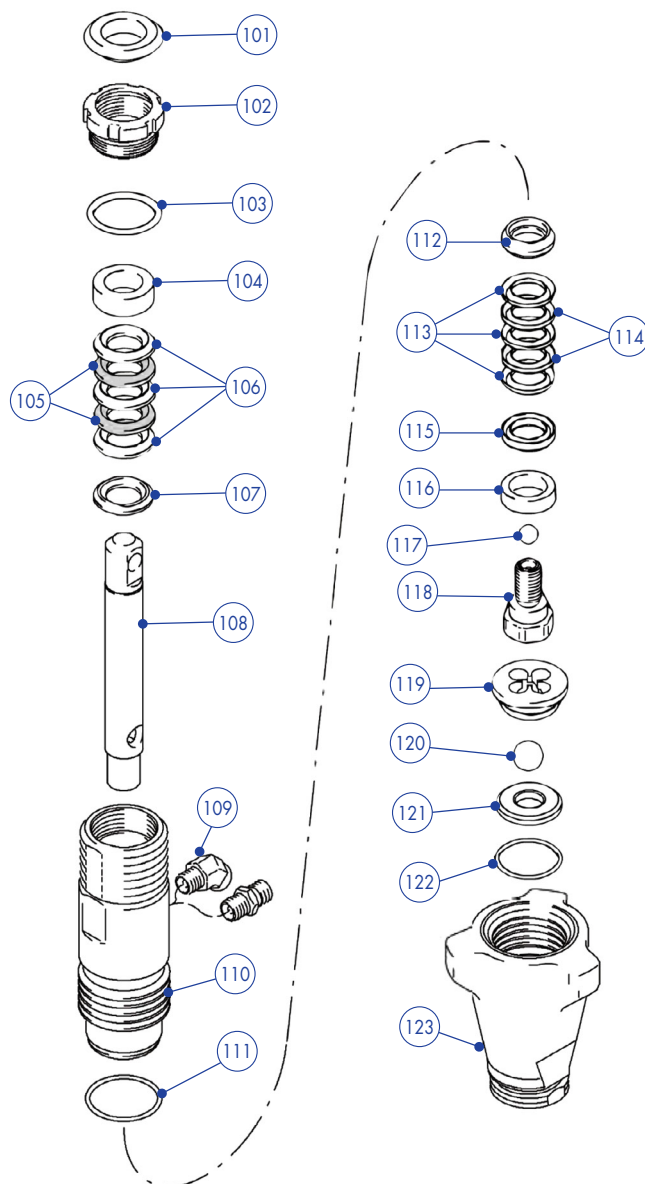

NO.	NAME	QUANTITY	NO.	NAME	QUANTITY	NO.	NAME	QUANTITY
101	Guide sleeve	1	109	Wire connector	2	117	Small ball	1
102	Packing nut	1	110	Intake sleeve	1	118	Steel ball seat	1
103	O-ring	1	111	O-ring	1	119	Ball guide	1
104	Positioning sleeve	1	112	Positioning sleeve	1	120	Big ball	1
105	Upper leather seal	2	113	Lower UPE seal	3	121	Big ball seat	1
106	Upper UPE seal	3	114	Lower leather seal	2	122	O-ring	1
107	Upper gland	1	115	Backup U-cup	1	123	Pump assembly	1
108	Piston rod	1	116	Lower gland	1			

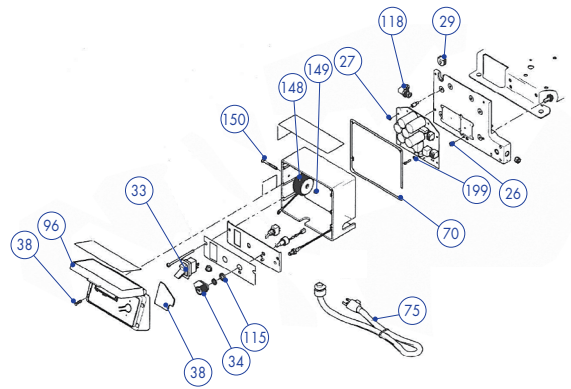

NO.	NAME	QUANTITY
26	Screw	1
27	Screw	1
29	Grommet, motor lead	1
33	ON/OFF switch	1
34	Pressure control knob	1
38	Screw	4
70	Control box gasket	1
75	Power cable	1

NO.	NAME	QUANTITY
96	DESC-Control	1
115	Gasket	1
118	Screw fitting	1
148	Coil	1
149	Nut	1
150	Screw	1
199	Spacer ring	1

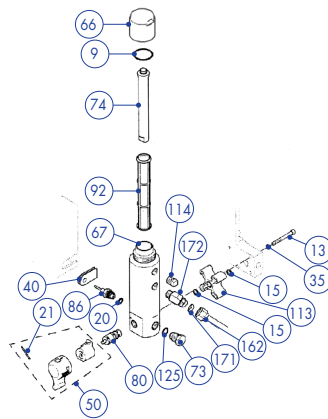

NO.	NAME	QUANTITY
9	O-ring seal	1
13	Screw cap	1
15	Square ring	2
20	O-ring	1
21	Pin	1
35	Washers lock spring	1

NO.	NAME	QUANTITY
40	Transducer	1
50	Handle set	1
66	Filter cap	1
67	Filter	1
73	Plug, self cleaning	1
74	Filter tube	1
80	Metal valve	1
86	Pressure sensor	1

NO.	NAME	QUANTITY
92	Suction filter	1
113	Manifold	1
114	Pipe plug	1
125	Oil seal	1
162	Fluid outlet	1
171	Seal	1
172	45 degree elbow joint	1

THIS PAGE INTENTIONALLY LEFT BLANK

SELLEYS®

IF IT'S SELLEYS IT WORKS™

A Trusted Australian Brand Since 1939

Selleys is a subsidiary of
Nippon Paint (Singapore) Co. Pte Ltd
1 First Lok Yang Road, Jurong, Singapore 629728
Tel: 6265 5355 (Main Line)
www.selleys.com.sg